



MELT PRESSURE ALARM

MODEL MP9410



- STANDARD**
- PRESSURE TRANSDUCER INPUT
 - SCALEABLE RANGE
 - ALARM HIGH
 - ALARM LOW
 - AUTO CALIBRATION
 - AUTO ZERO
 - LOCKOUT
 - PROCESS VALUE - RETRANS

MODEL CODE

MP9410-PRR-		RETRANSMISSION of PROCESS VALUE
M	4-20mA	
0	0-10mA	
1	0-20mA	
5	0-5VDC	
6	1-5VDC	
10	0-10VDC	

TERMINAL CONFIGURATION

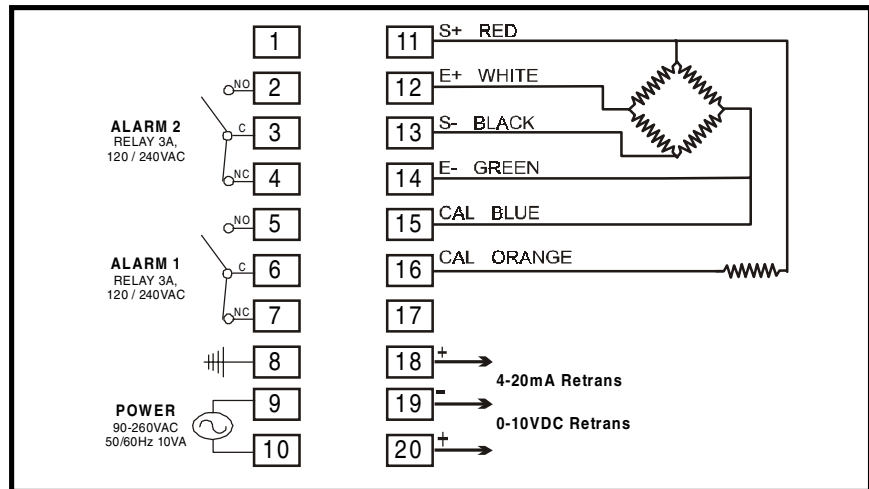

SPECIFICATIONS - MP9410

1. INPUT - PRESSURE TRANSDUCER

350ohm STRAIN GAUGE 2.00-4.00mV/V standard 3.30mV/V
 EXCITATION VOLTAGE 10VDC
 ACCURACY +/-0.5%
 SAMPLE RATE 100mS

2. ALARM OUTPUTS

ALARM 1 5A/240VAC resistive NO/NC
 ALARM 2 5A/240VAC resistive NO/NC

3. RETRANSMISSION of PROCESS VALUE

CURRENT 4-20mA, 0-20mA, 0-10mA Max load 500 ohm
 VOLTAGE 0-5VDC, 1-5VDC Max 20mA

4. POWER

RATING 85 - 265 VAC 50/60Hz 10VA max

5. ENVIRONMENTAL

OPERATING TEMP -10 - 50C
 HUMIDITY 90% MAX
 INSULATION 20M ohms minimum @ 500VDC
 WEIGHT 300g

6. PHYSICAL DIMENSIONS

MP9410 96mmW x 48mmH x 100mmD
 MP9410 Cutout 91mmW x 45mmH +/-0.5mm
 MP9610 96mmW x 96mmH x 100mmD
 MP9610 Cutout 91mmW x 91mmH +/-0.5mm

TOLL FREE (800) 817-3486

PH (416) 675-7329

FX (416) 675-7349

ZERO DISPLAY

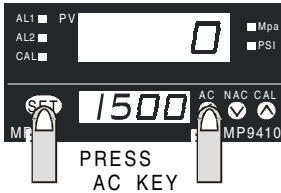
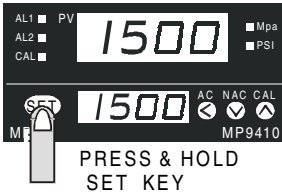
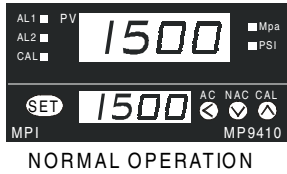

AUTO CAL

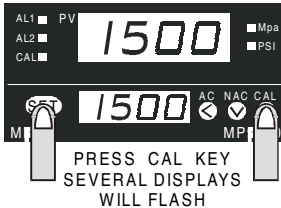
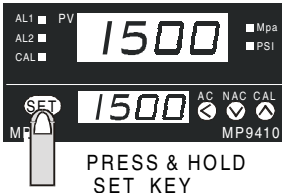
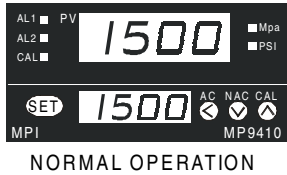

CHANGE ALARM 1 (AL1)

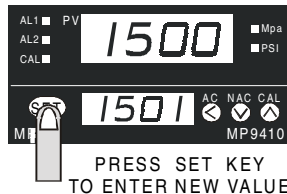
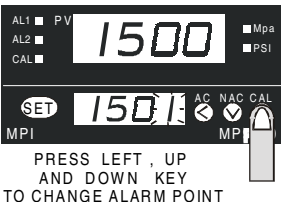
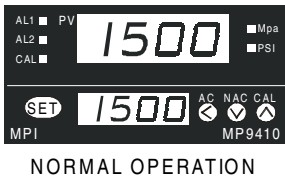

CHANGE ALARM 2 (AL2)

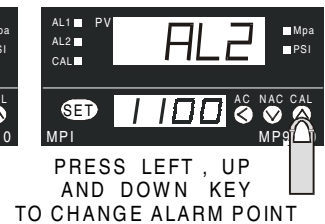
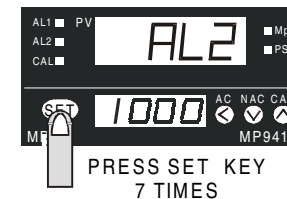
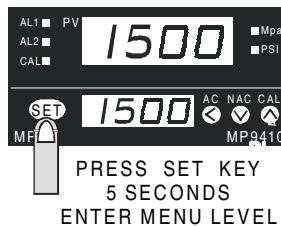
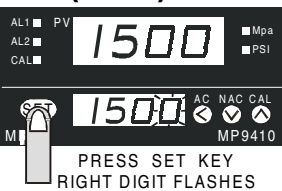
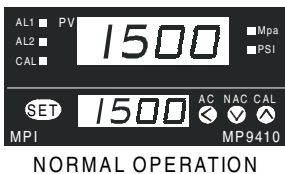

CODE	PARAMETER	RANGE	DEFAULT
rn	MEASUREMENT RANGE	500 - 9999	9999
du	DISPLAY GRADUATION	1, 2, 5	5
dot	DO NOT ADJUST	DO NOT ADJUST	DO NOT ADJUST
AL1	ALARM 1	0 - 9999	8000
SEL1	ALARM 1 TYPE	0 - NONE 1 - LOW ALARM 2 - HIGH ALARM	2 - HIGH ALARM
dLY1	ALARM 1 HYSTERESIS	0 - 100	10
AL2	ALARM 2	0 - 9999	1000
SEL2	ALARM 2 TYPE	0 - NONE 1 - LOW ALARM 2 - HIGH ALARM	1 - LOW ALARM
dLY2	ALARM 2 HYSTERESIS	0 - 100	10
ESC	DO NOT ADJUST	DO NOT ADJUST	DO NOT ADJUST
OUT	RETRANS PROCESS VALUE	0u10 0-10Vdc 4-20 4-20mA 0-20 0-20mA	0-10 0-10mA 0-5 0-5Vdc 4-20 4-20mA
LCK	LOCK	0000 - NO LOCK 0001 - ALL LOCKED	0000 - NO LOCK

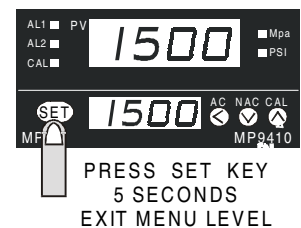



**TORONTO, ONTARIO
CANADA**
PH (416) 675-7329
FX (416) 675-7349

DISTRIBUTOR